

# 江西省晶能半导体有限公司

JiangXi LatticePower Semiconductor Corporation

## 产品规格书 Specification

产品名称 Product Name: LAWD

产品型号 Product P/N: HH

客户 Client name: \_\_\_\_\_

客户料号 Client P/N: \_\_\_\_\_

版本号 Version No.: A04

日期 Sending Date: 2024.03

客户承认栏 Client Approval	
核准 Approval	确认 Audit

制定 Confirmation: \_\_\_\_\_ 审核 Approval: \_\_\_\_\_

工厂地址:江西省南昌市高新区艾溪湖北路 699 号

Address: No.699 Aixihu North Road, Nanchang, Jiangxi Province, China

# 目录 Contents

1、特点 Features .....	1
2、应用 Applications .....	1
3、性能 Performance .....	2
4、产品代码 Product Order Code .....	5
5、分档规则 Bin Regulations.....	6
6、光电特性图 The Photoelectric Characteristics Graph .....	9
7、产品及钢网尺寸 Product and PCB Pad Dimensions.....	12
8、回流焊特性 Reflow Soldering Characteristics .....	13
9、卷轴 Reel Dimensions .....	14
10、可靠性 Reliability.....	15
11、注意事项 Cautions.....	17
12、文件履历表 Document Resume .....	18

## 1、特点 Features

- ◆ EMC 封装，高亮度，高可靠性，主要用于汽车应用  
EMC package ,High brightness ,High efficiency ,It is mainly used in automobile applications
- ◆ 尺寸：3.7mm\*3.50mm\*0.75mm  
Size: 3.7mm\*3.50mm\*0.75mm
- ◆ 根据白光标准分档  
According to standard white color gamut
- ◆ 通过 RoHS 认证  
RoHS compliant
- ◆ MSL 等级 2a  
MSL 2a
- ◆ 适于 SMT 贴片  
Compatible with SMT
- ◆ 发光角度：120°  
Viewing Angle: 120°
- ◆ 包装：最大 1500 颗/卷  
Package: Max: 1500pcs /reel
- ◆ 建议额定使用电流为 140mA  
Recommended current 140mA
- ◆ 通过 AEC-Q102  
AEC-Q102 Qualified

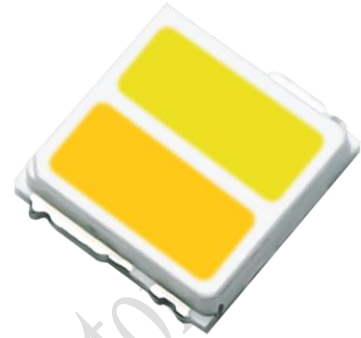

## 2、应用 Applications

汽车内外部照明

Interior and exterior lighting for automotive



### 3、性能 Performance

#### a) 极限参数 Maximum Ratings

参数 Parameter	符号 Symbol	数值 Rating	单位 Unit
最大正向电流 Max DC Forward Current	$I_F$	200	mA
功率 Power Dissipation	P	0.5	W
峰值正向电流 Peak Forward Current	$I_{FP}$	400	mA
最大反向电压 Maximum Reverse Current		不可施加反向电压 Do not apply for reverse current	
结温 (DC 模式) LED Junction Temperature(DC mode)	$T_j$	150	°C
工作温度 Operating Temperature Range	$T_{opr}$	-40~125	°C
存储温度 Storage Temperature	$T_{stg}$	-40~125	°C
ESD (人体模式) ESD Human Body Mode	----	8000	V

备注 Notes :

- ◇ 绝对最大额定值环境温度  $T_a=25^{\circ}\text{C}$   
Absolute Maximum Ratings at  $T_a=25^{\circ}\text{C}$
- ◇  $I_{FP}$  脉冲时间 $\leq 10\text{ms}$ ，宽度 $\leq 10\%$   
 $I_{FP}$  Conditions with pulse width  $\leq 10\text{ms}$  and duty cycle $\leq 10\%$

b) 光电参数 Electro-Optical Characteristics (T solder pad =25 °C, I<sub>F</sub> =140mA)

项目 Item	符号 Symbol	最小值 Min.	典型值 Typ.	最大值 Max.	单位 Unit
光通量 Luminous Flux	Φ (White)	40	55	70	Lm
	Φ (Amber)	30	45	60	
正向电压 Forward Voltage	VF	2.75	3.0	3.50	V
色坐标 Color Coordinate	X(White)	--	0.33	--	
	Y(White)		0.33		
	X(Amber)	0.577	--		
	Y(Amber)	0.418			
显指 Ra	Ra (white)	70			
反向电流 Reverse Current (V <sub>R</sub> =5V)	I <sub>R</sub>	--	--	1	uA
实际热阻 PN/焊点 Real Thermal Resistance (Junction to Solder point)	RthJS real		30		°C/W
电热阻 PN/焊点 Electrical Thermal Resistance (Junction to Solder point)	RthJS elec.		25		°C/W
发光角度 Viewing Angle	2θ		120		°

备注 Notes :

◇ 光通量测量误差范围±8%

Luminous flux measurement tolerance: ±8%

◇ 光电参数测试是瞬态时间为 20ms

Electric and optical data is tested at 20 ms pulse condition

c) 亮度分布特性 Luminous Flux Characteristics (T solder pad = 25 °C, I<sub>F</sub> =140mA)

产品型号 Product	White 色区 块 Chromaticity	Amber 色区 块 Chromaticity	最小光通量 Minimum Luminous Flux		出货代码 (例) Order Code (e. g.)
			代码 Code	亮度值 Value	
LAWD	B3 6300~7000K	5E 1600K~1950K	R12R11	50/40	HH-C-B3-R12-DD7-N-5E- R11-D678
			C1R11	60/40	
			R12R12	50/50	
			C1R12	60/50	
	B4 5700~6300K	5E 1600K~1950K	R12R11	50/40	HH-C-B4-R12-DD7-N-5E- R11-D678
			C1R11	60/40	
			R12R12	50/50	
			C1R12	60/50	
	B5 5300~5700K	5E 1600K~1950K	R12R11	50/40	HH-C-B5-R12-DD7-N-5E- R11-D678
			C1R11	60/40	
			R12R12	50/50	
			C1R12	60/50	
	B6 4900~5300K	5E 1600K~1950K	R12R11	50/40	HH-C-B6-R12-DD7-N-5E- R11-D678
			C1R11	60/40	
			R12R12	50/50	
			C1R12	60/50	

## 4、产品代码 Product Order Code

HH - C - B4 - R11 - DD7 - N - 5E - DR - DD678  
 ①            ②            ③            ④            ⑤            ⑥            ⑦            ⑧            ⑨

- ① 产品型号      Product Type (HH:LAWD)
- ②⑥ 显色指数      Ra level
- ③⑦ 色温区块      Color Area
- ④⑧ 亮度等级      Brightness Level
- ⑤⑨ 电压等级      VF Level

### 出货标签(例) Shipping label (e.g.)



**LatticePower Corporation Limited**

LatticePower Item: HH-C-B4-R11-DD7-N-5E-DR-D678 LAWD  

MSL 2a Reel ID: AHHC00000001  



Qty: 1500      6HHDAACA  
      Date:2023-07-25



### 5、分档规则 Bin Regulations

#### a) 色度区域 Chromaticity Regions (T solder pad = 25°C, I<sub>F</sub> =140 mA)

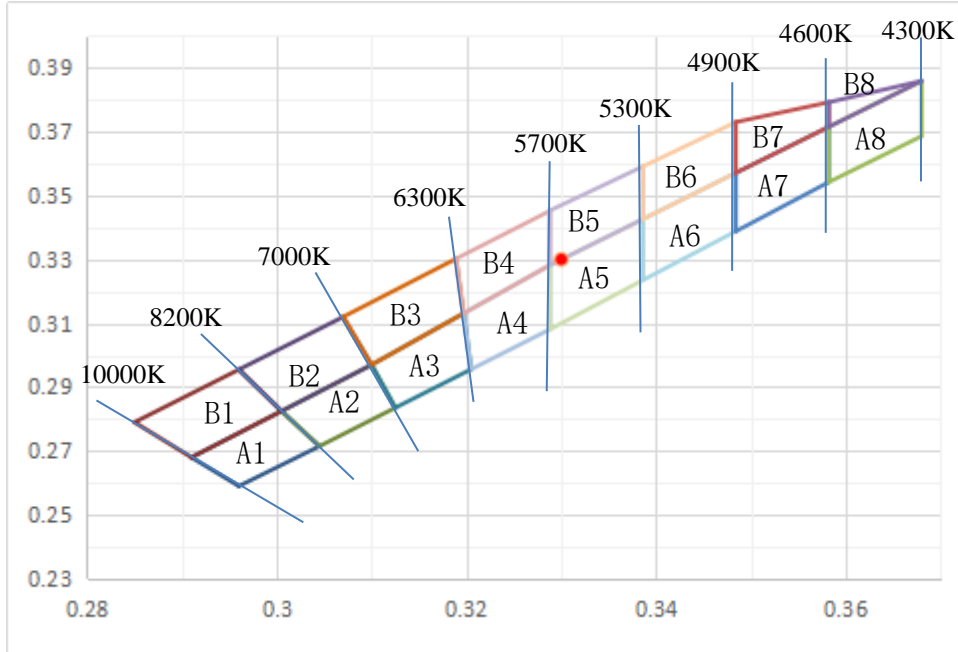
White



Amber

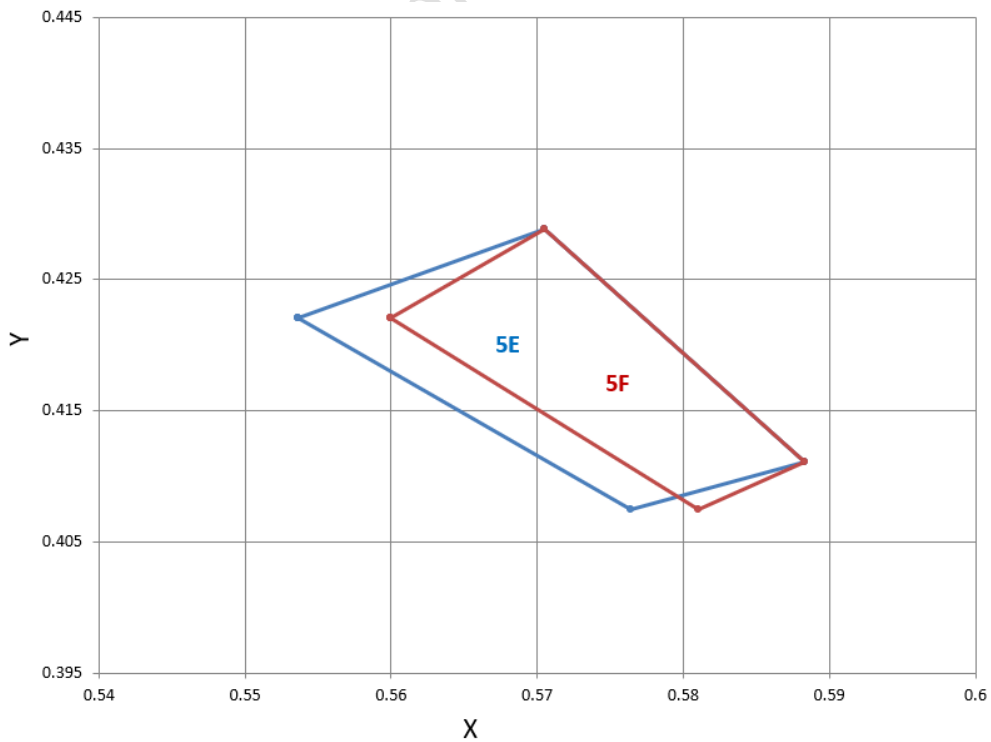





**Color Chromaticity Groups**

Color Bin	x	y	Color Bin	x	y
A1 8200K~10000K	0.296	0.259	B1 8200K~10000K	0.291	0.268
	0.291	0.268		0.285	0.279
	0.3005	0.2825		0.296	0.2955
	0.3045	0.2715		0.3005	0.2825
A2 7000K~8200K	0.3045	0.2715	B2 7000K~8200K	0.3005	0.2825
	0.3005	0.2825		0.296	0.2955
	0.31	0.297		0.307	0.312
	0.3125	0.28355		0.31	0.297
A3 6300K~7000K	0.31	0.297	B3 6300K~7000K	0.307	0.312
	0.3197	0.3131		0.3189	0.3302
	0.3205	0.2956		0.3197	0.3131
	0.3125	0.28355		0.31	0.297
A4 5700K~6300K	0.3197	0.3131	B4 5700K~6300K	0.3189	0.3302
	0.3288	0.3282		0.3288	0.3452
	0.3288	0.3081		0.3288	0.3282
	0.3205	0.2956		0.3197	0.3131
A5 5300K~5700K	0.3288	0.3081	B5 5300K~5700K	0.3288	0.3282
	0.3288	0.3282		0.3288	0.3453
	0.3386	0.3426		0.3386	0.3591
	0.3386	0.3235		0.3386	0.3426
A6 4900K~5300K	0.3386	0.3235	B6 4900K~5300K	0.3386	0.3426
	0.3386	0.3426		0.3386	0.3591
	0.3484	0.3571		0.3484	0.373
	0.3484	0.3388		0.3484	0.3571
A7 4600K~4900K	0.3484	0.3388	B7 4600K~4900K	0.3484	0.3571
	0.3484	0.3571		0.3484	0.373
	0.3582	0.3715		0.3582	0.3792
	0.3582	0.3542		0.3582	0.3715



A8 4300K~4600K	0.3582	0.3542	B8 4300K~4600K	0.3582	0.3715
	0.3582	0.3715		0.3582	0.3792
	0.368	0.3859		0.368	0.3859
	0.368	0.3686			
5E 1600K~1950K	0.5536	0.4221	5F 1600K~1950K	0.5600	0.4221
	0.5764	0.4075		0.5810	0.4075
	0.5883	0.4111		0.5883	0.4111
	0.5705	0.4289		0.5705	0.4289

LatticePower Semiconductor

备注 Notes :

- ◇ 色度坐标 (x, y) 来自 CIE1931 色度图

The chromaticity coordinates(x,y)is derived from the CIE 1931 chromaticity diagram

- ◇ PT86 测试设备用于光通量 (lm) 和 CIE1931 色度坐标 (x, y) 测试。

PT86 is for the luminous flux(lm) and the CIE1931 chromaticity coordinates(x,y) testing.

- ◇ 色度坐标 (x, y) 存在±0.006 公差。

The chromaticity coordinates(x,y) guarantee should be added ±0.006 tolerance.

**b) 亮度分档 Luminous Flux Groups (T solder pad = 25°C, I<sub>F</sub> =140 mA)**

white		amber	
代码 Group Code	范围 Range	代码 Group Code	范围 Range
R11	40~50	DR	30~40
R12	50~60	R11	40~50
C1	60~70	R12	50~60

**c) 电压分档 Voltage Groups (T solder pad = 25°C, I<sub>F</sub> =140 mA)**

Group Code	Range
DD6	2.75~3.00
DD7	3.00~3.25
DD8	3.25~3.50

**d) 显指分档 Ra Groups (T solder pad = 25°C, I<sub>F</sub> =140 mA)**

white		amber	
代码 Group Code	范围 Range	代码 Group Code	范围 Range
C	70~100	N	0~100

备注 Notes :

- ◇ 亮度测试存在±8%的公差  
It maintains a tolerance of ±8% on luminous flux measurements.
- ◇ 电压测试误差±0.1V  
Forward voltage(VF) ± 0.1V



## 6、光电特性图 The Photoelectric Characteristics Graph

Fig 1. 辐射特性 / Radiation Characteristics

IF=140mA; TS = 25°C

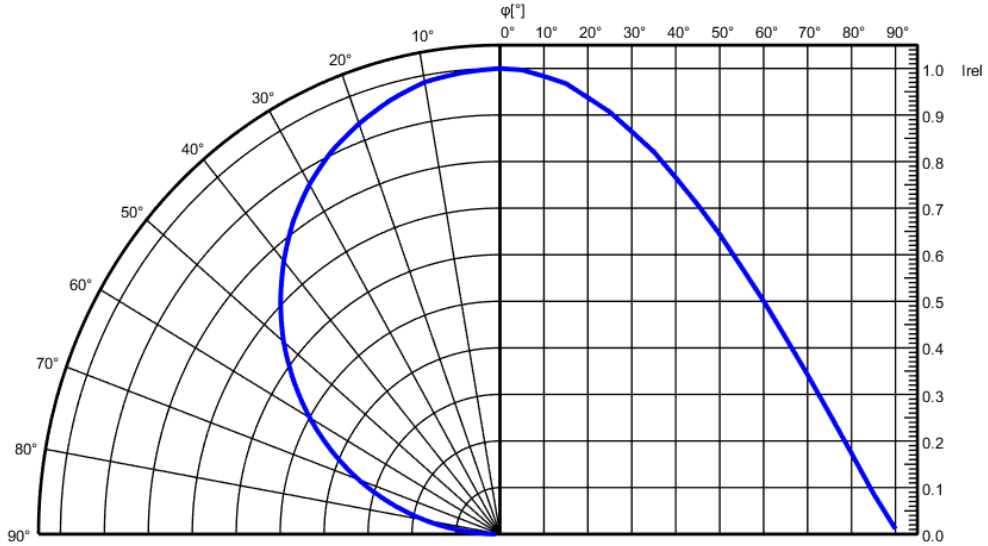
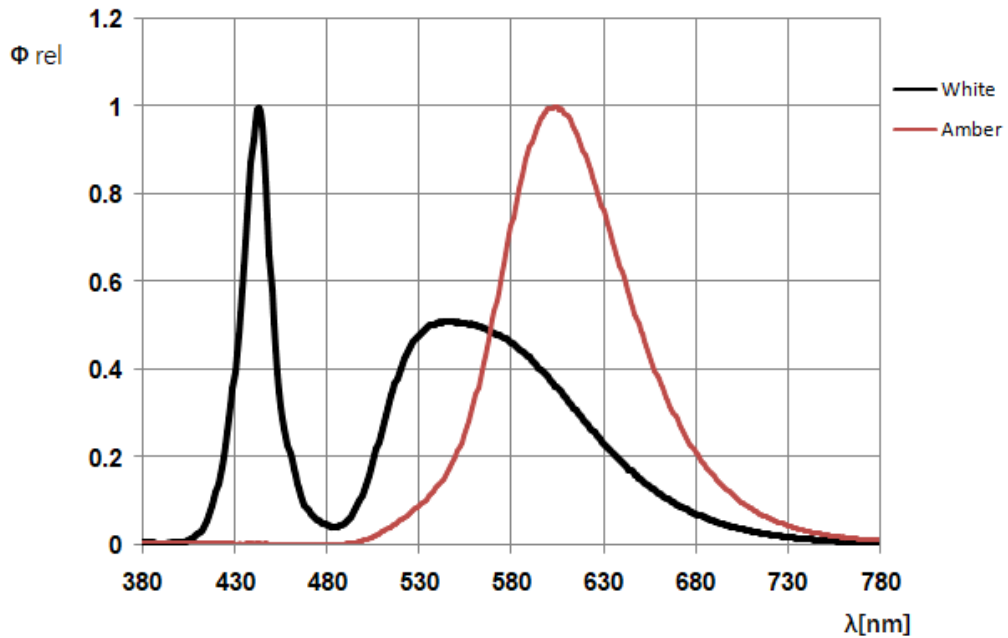

Fig 2. 相对发光光谱/ Relative Spectral Power Distribution vs. Wavelength

$\Phi_{rel}=f(\lambda)$ ; IF=140mA; TS = 25°C



**Fig 3. 正向电流/Forward Voltage**

$I_F = f(V_F); TS = 25^\circ\text{C}$

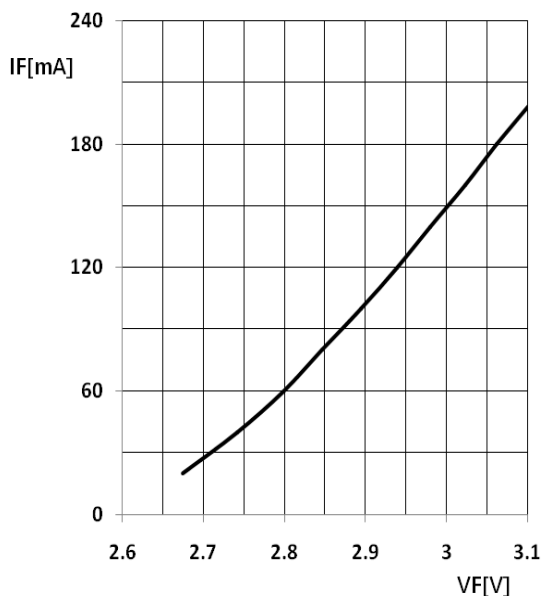

**Fig 4. 相对发光强度/Relative Luminous Intensity**

$I_v / I_v(140\text{ mA}) = f(I_F); TS = 25^\circ\text{C}$

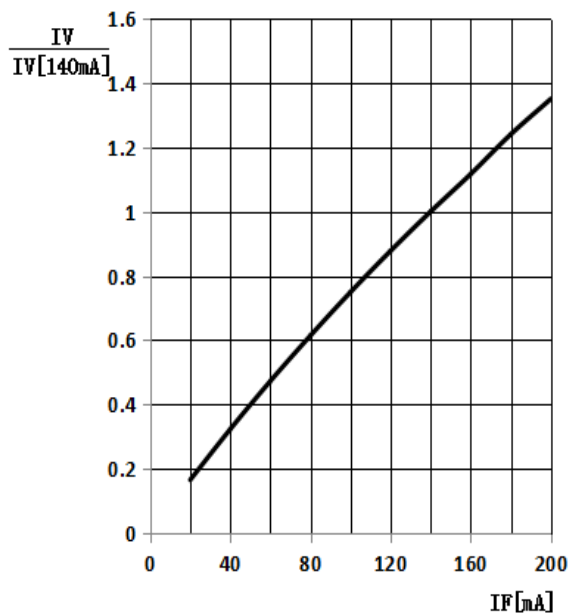

**Fig 5. 色坐标偏移/Chromaticity Coordinate Shift**

$\Delta C_x, \Delta C_y = f(I_F); TS = 25^\circ\text{C}$

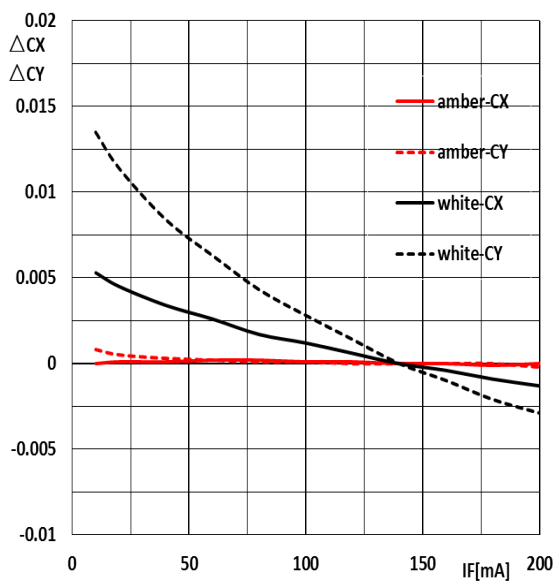

**Fig 6. 正向电压/Forward Voltage**

$\Delta VF = VF - VF(25^\circ C) = f(T_j); I_F = 140mA$

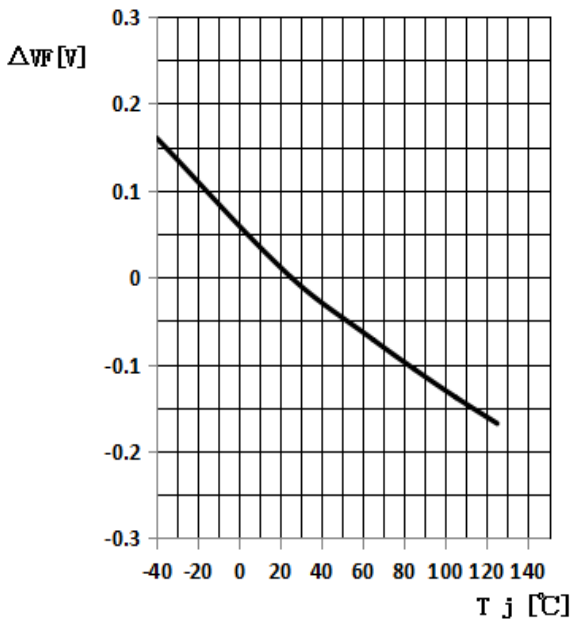

**Fig 7. 相对发光强度 Relative Luminous Flux**

$I_v / I_v(25^\circ C) = f(T_j); I_F = 140mA$

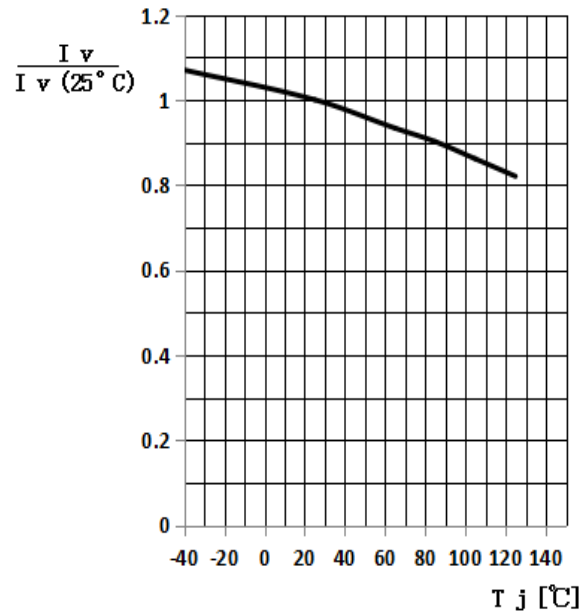

**Fig 8. 色坐标偏移/**

**Chromaticity Coordinate Shift**

$\Delta C_x, \Delta C_y = f(I_F); T_S = 25^\circ C$

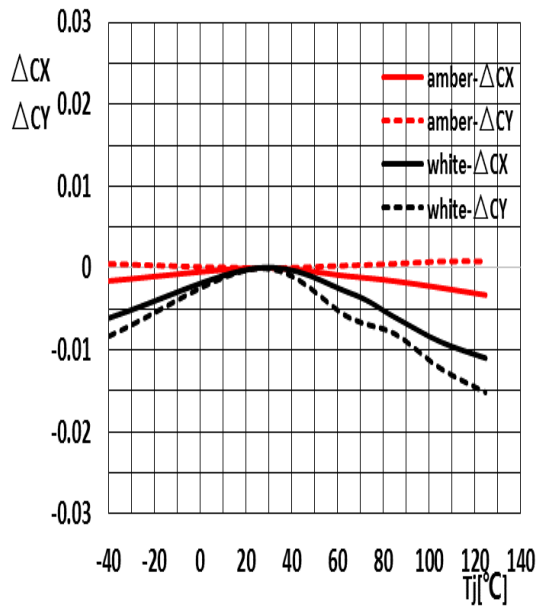

**Fig 9. 最大正向电流/**

**Max. Permissible Forward Current**

$I_F = f(T)$

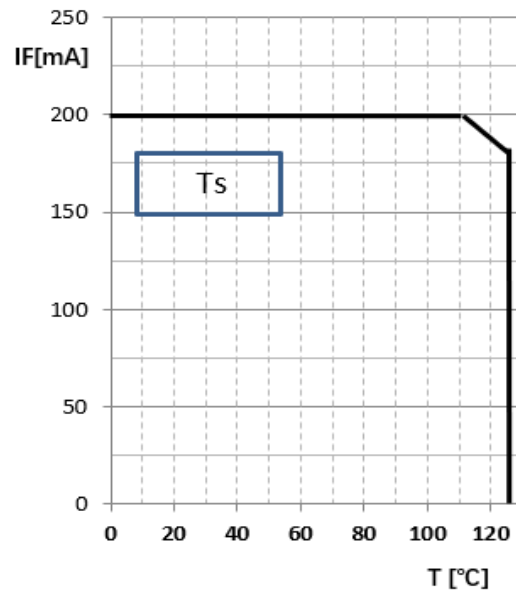



## 7、产品及钢网尺寸 Product and PCB Pad Dimensions

### a) 产品尺寸 Product Dimensions:

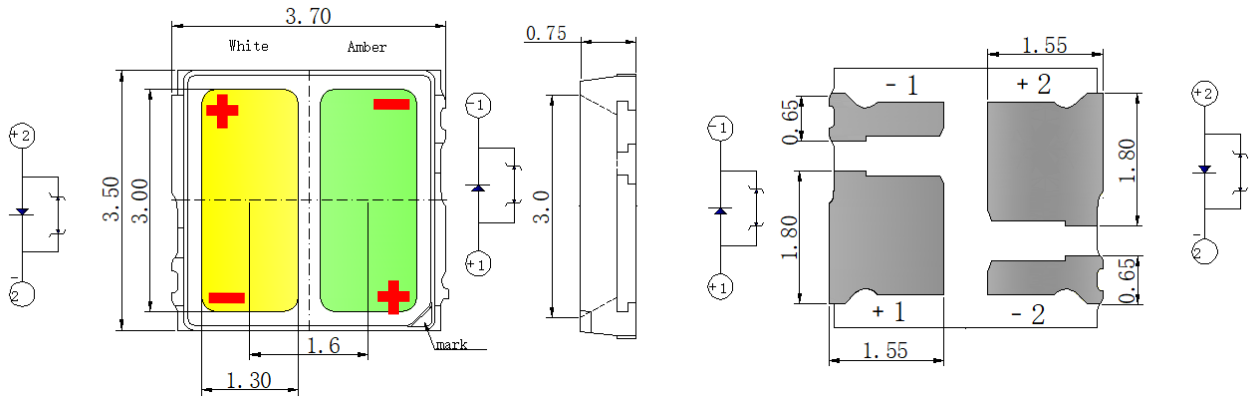

### b) 推荐焊盘尺寸 PCB Pad Dimensions

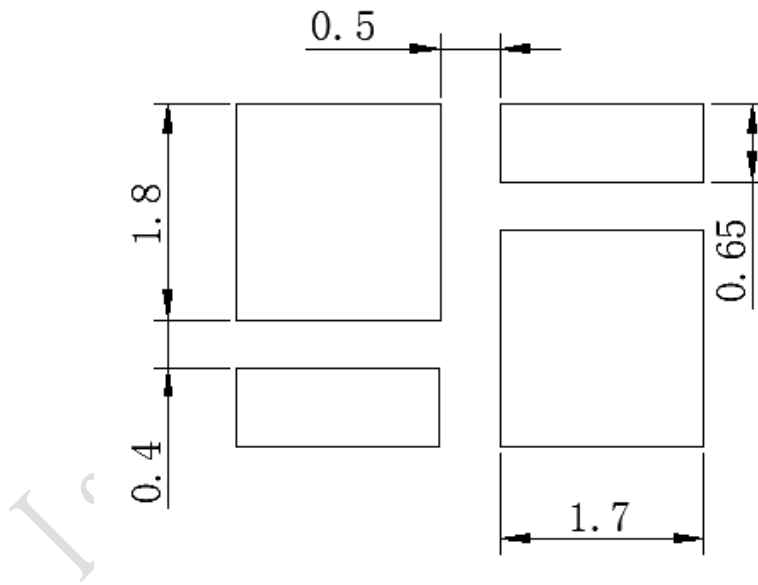

#### 备注 Notes:

- ◇ 所有尺寸均以 mm 为单位  
All dimensions are in millimeters
- ◇ 尺寸未按照公差±0.15mm 标记的，按照图纸标记  
Size is not marked in accordance with tolerance ±0.15mm and dimension tolerances in accordance with drawings
- ◇ 灯珠近似重量: 28.9mg  
Approximate Weight: 28.9mg



## 8、回流焊特性 Reflow Soldering Characteristics

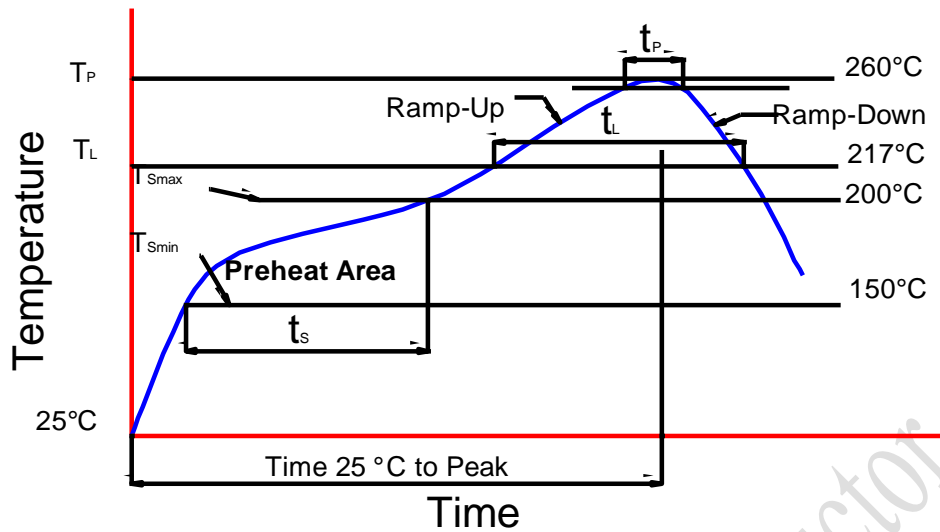

根据 EDEC-J-STD-020E 内容，参考以下内容。  
Compatible with the JEDEC-J-STD-020E, using the parameters listed below.

特制参数 Profile Feature	无铅焊料 Lead-Free Solder
平均上升速率 (T <sub>Smax</sub> 至 T <sub>P</sub> ) Average Ramp-Up Rate (T <sub>Smax</sub> to T <sub>P</sub> )	3 °C/sec max.
预热: 温度最小值 (T <sub>Smin</sub> ) Preheat: Temperature Min (T <sub>Smin</sub> )	150
预热: 最高温度 (T <sub>Smax</sub> ) Preheat: Temperature Max (T <sub>Smax</sub> )	200
预热: 时间 (t <sub>Smin</sub> 到 t <sub>Smax</sub> ) Preheat: Time (t <sub>Smin</sub> to t <sub>Smax</sub> )	60-180 secs
回流温度 (T <sub>L</sub> ) Time Maintained Above: Temperature (T <sub>L</sub> )	217°C
回流时间 (t <sub>L</sub> ) Time Maintained Above: Time (t <sub>L</sub> )	60-150 secs
峰值/分类温度 (T <sub>P</sub> ) Peak/Classification Temperature (T <sub>P</sub> )	255 ± 5°C
实际峰值温度 (t <sub>p</sub> ) 在 5°C 以内的时间 Time Within 5°C of Actual Peak Temperature (t <sub>p</sub> )	20~40 secs
降低速率 Ramp-Down Rate	4°C/sec max.





### 9、卷轴 Reel Dimensions

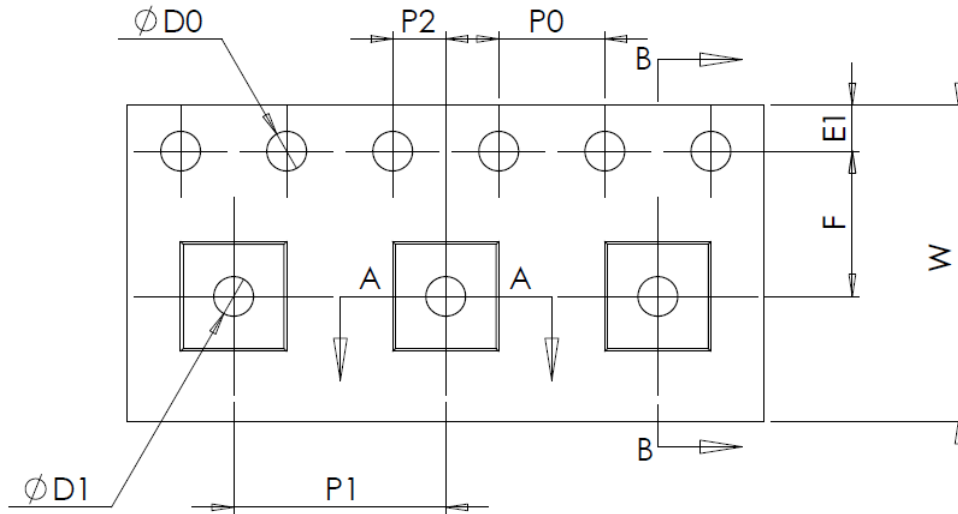

A0	$3.8 \pm 0.1$
B0	$3.95 \pm 0.1$
K0	$1.20 \pm 0.1$
F	$5.5 \pm 0.05$
P1	$8 \pm 0.1$
W	$12 + 0.3 / -0.1$

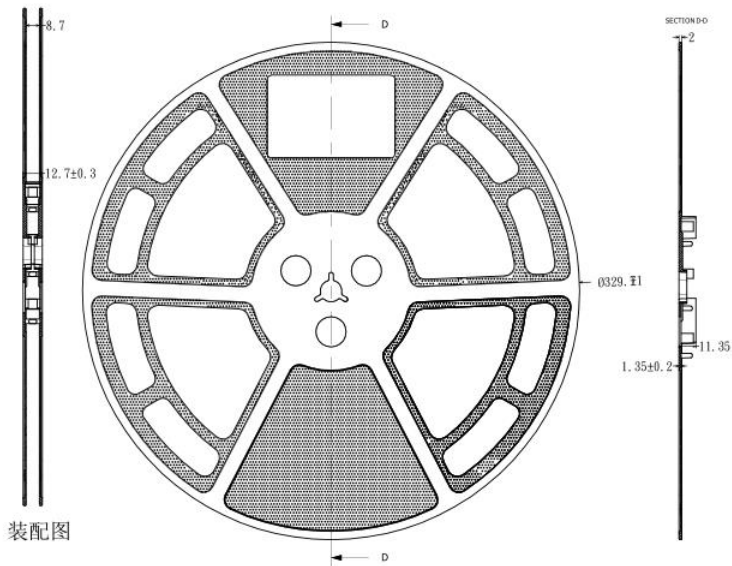

装配图

备注 Notes:

- ◇ 卷轴包装: 1500pcs  
Reel:1500pcs.
- ◇ 卷轴包装方法符合 IJSC0806 (连续胶带上的电子元件包装)  
The tape packing method complies with IJSC0806(Packing of Electronic Components on Continuous Tapes).
- ◇ 当卷轴由于工作中断而重绕时, 载带上压力不应超过 10N, 否则 LED 可能会粘在盖带上  
When the tape is rewound due to work interruptions, no more than 10N should be applied to the embossed carrier tape.  
The LEDs may stick to the cover tape.

## 10、可靠性 Reliability

### a) 测试和结果 Tests and Results

测试项目 Test Item	标准 Reference Standard	测试条件 Test Conditions	测试周期 Test Duration	失效标准 Failure Criteria#
外观检测 External Visual	JESD22 B-101	Visual Inspection	/	#1
破坏性物理分析 D.P.A	AEC-Q102	Random Sample HSTRB,HAST,TC	/	#1
振动 Vibration	JESD22 B-103	0.06 inch displacement,20 to 100 Hz,50 g 100 Hz to 2kHz,	4times	#1
静电测试 ESD	JESD22 A-114	Human-body mode, R = 1.5 k $\Omega$ , C = 100pF	3 times Negative/ Positive	#1
机械冲击 Mechanical Shock	JESD22 B-104	1500 g's for 0.5 ms, 5 blows, 3 orientations	3times	#1
常温测试 Life Teat	JESD22 A-108	25°C, 1000 hours @200mA	1000hrs	#1
温度循环 Power Temperature Cycle	JESD22 A-105	Ta = -40°C~ 85°C, If = 200mA, 20 min dwell / 20 min transition (1 hour cycle), 2 min ON / 2 min OFF	1000hrs	#1
高温高湿测试 High Humidity High Temp. Operating Life	JESD22 A-101	85°C/85% RH, @ 200mA	1000hrs	#1
高温老化 High Temperature Operating Life	JESD22 A-108C	Ts = 125°C, If = 200mA	1000hrs	#1
低温老化 Low Temperature Operating Life	JESD22 A-108C	Ta = -40°C, If = 200mA	1000hrs	#1
低温储存 Low Temperature Storage Life	JESD22 A-119	Ta = -40°C, non-operating	1000hrs	#1
高温储存 Hight Temperature Storage Life	JESD22 A-103B	Ta = 125°C, non-operating	1000hrs	#1
冷热冲击 Thermal Shock	JESD22 A-104	-40°C ~ 125°C, 1000 cycles	1000cycles	#1



## b) 失效标准 Failure Criteria

Criteria #	Items	Conditions	Failure Criteria
#1	Forward Voltage ( $V_F$ )	$I_F$	$> \text{Initial value} \times 1.1$ or $< \text{Initial value} \times 0.9$
	Luminous Flux ( $\Phi_v$ )	$I_F$	$< \text{Initial value} \times 0.7$

LatticePower Semiconductor

## 11、注意事项 Cautions

### a) 存储 Storage

- 不要将芯片放在潮湿的地方，存放温度在 5°C~30°C之间，相对湿度在 30%以下。  
Do not place the chips in damp places, Storage temperature between 5 °C and 30 °C, Relative humidity under 30%.
- 开包后建议在 24 小时内过完回流焊，车间条件≤30°C/60%RH。  
After opening the package, it is recommended to finish the reflow within 24 hours. The workshop conditions are ≤30°C/60%RH
- 如果受潮，需将贴片卷盘放入 60°C烤箱烘烤 24 小时；打开后，LED 灯可重新密封在原始真空袋中。  
If it is wet, the patch reel should be baked in a 60 ° C oven for 24 hours; after opening, the LED light can be resealed in the original vacuum bag.
- 不要接触任何未知的液体，特别是丙酮。  
Don't touch any unknown liquid, In particular, acetone.
- 防止静电死亡，手动操作需要戴橡胶手套并佩戴静电环。  
Prevent electrostatic killed, Manual operation is required to wear rubber gloves and wear electrostatic ring.

### b) 清洗 Cleaning

- 通常，LED 不建议对部件进行湿式清洁处理，因为封装不是密封的。  
In general, LED does not recommend a wet cleaning process for component as the package is not hermetically sealed.
- 由于采用开放式设计，所有类型的清洁液都可能渗透到封装中，导致 LED 退化或完全失效。  
Due to the open design, all kind of cleaning liquids can infiltrate the package and cause a degradation or a complete failure of the LED.

### c) 操作注意 Handling Precautions

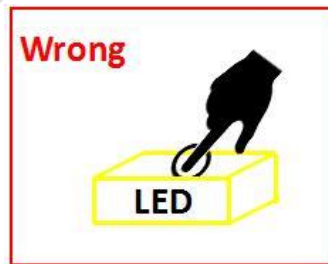

- 在处理过程中，还应注意确保组件顶面没有压力。  
During the handling, care should be taken as well to ensure no pressure on the top surface of component.
- 应避免使用所有类型的尖锐物体（例如镊子，指甲等），以防止对硅树脂造成压力，因为这会导致部件损坏。  
All types of sharp objects(e.g. forceps, fingernail, etc) should be avoided in order to prevent stress to the silicone, since this can lead to damage of the component.



## 12、文件履历表 Document Resume

序号	变更日期	变更人	版本	变更内容
01	2022.04.13	袁丁	Y00	1.新制定;
02	2022.06.01	袁丁	Y01	1.修改满卷颗粒数, 由满卷 1000pcs 变更为 1500pcs;
03	2022.06.25	袁丁	Y02	1.产品属性由“LXD”变更为“LAWD”;
04	2022.08.18	袁丁	Y03	1. BIN 级别体现方式变更, 例如由“HH-CN-B3-R11DR-DD7”, 变更为“HH-C-B3-R11-DD7-N-5E-DR-D678”;
05	2023.02.07	袁丁	A01	1. 标签增加“MSL 2a”标识;
06	2023.07.25	袁丁	A02	1.更新公司标签抬头;
07	2023.09.15	袁丁	A03	1. 增加白光亮度档位 C1 以及增加琥珀色 R12 档位;
08	2024.03.09	李俊杰	A04	<ol style="list-style-type: none"> <li>1. 删除最小正向电流;</li> <li>2. 新增 5F 色区;</li> <li>3. 更新 LED 高度;</li> <li>4. 新增 LED 质量信息;</li> </ol>